

## CrawlerCR-1004

50W Rectangular LED Agricultural Work Light

### MATERIALS

Weight:1600g

Housing Material: Die Cast Aluminum, Black Powder Coated Finish

Lens Material: Polycarbonate, Hard Coated & UV protected

Heat management: Natural Convection, Heat Sink

Mounting type: Mounting bracket & screws

Waterproof Rate: IP67

### OPTICS

Beam pattern	Spot with 40 degrees
Power:	50W
Lumens:	5000 lms

### ELECTRONIC CHARACTERISTICS

LED chips: 12 pcs 5W OSRAM LEDs

Operation Voltage: 9-32V DC

Operation temperature:-40 C to 80 C

### CERTIFICATES

CE,RoHS,

EMC: CISPR25 CLASS 4

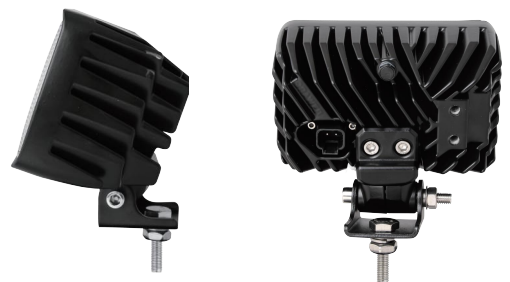

## PRODUCT SIZE:

Bottom bracket

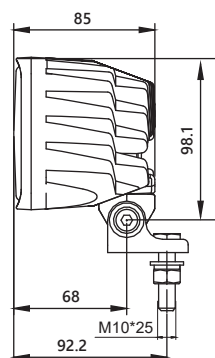
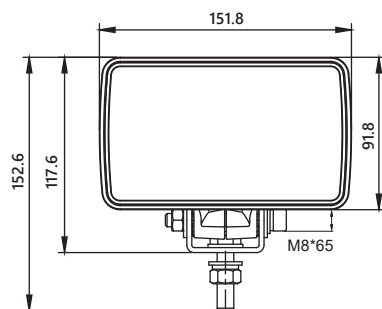

Side bracket

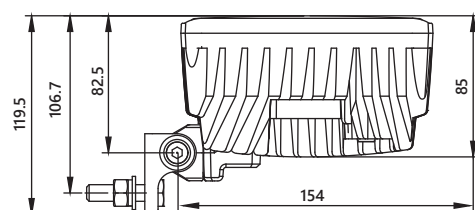
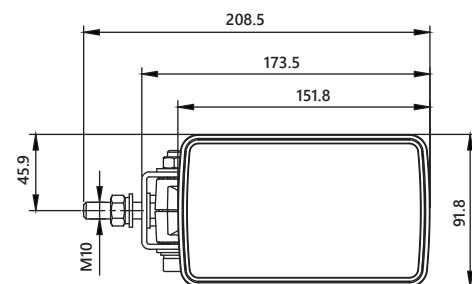

## WIRE COLOR & FUNCTIONS

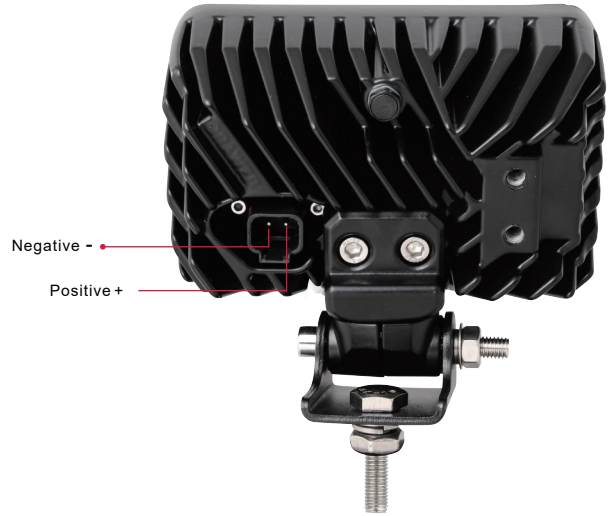
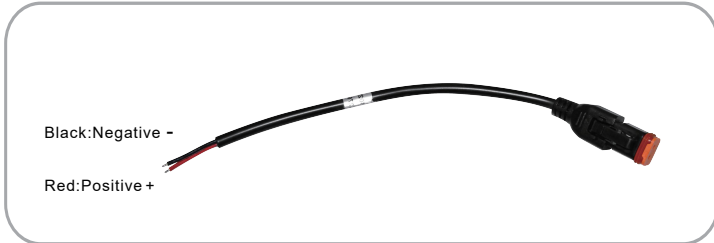

## BRACKET IS OPTIONAL

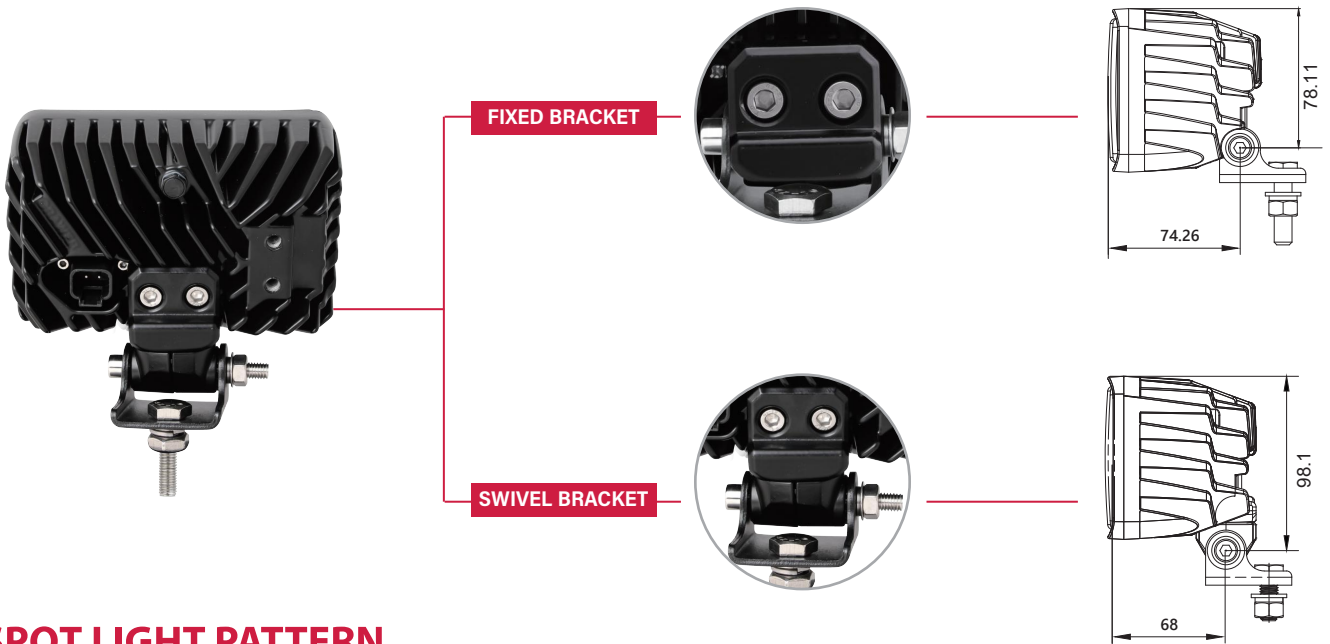

## SPOT LIGHT PATTERN

